

COMSOL MULTIPHYSICS®

Martin Kožíšek

kozisek@humusoft.cz

www.linkedin.com/in/martinkozisek

+420 284 011 745

 COMSOL®

Fyzikální jev



Počítačová simulace

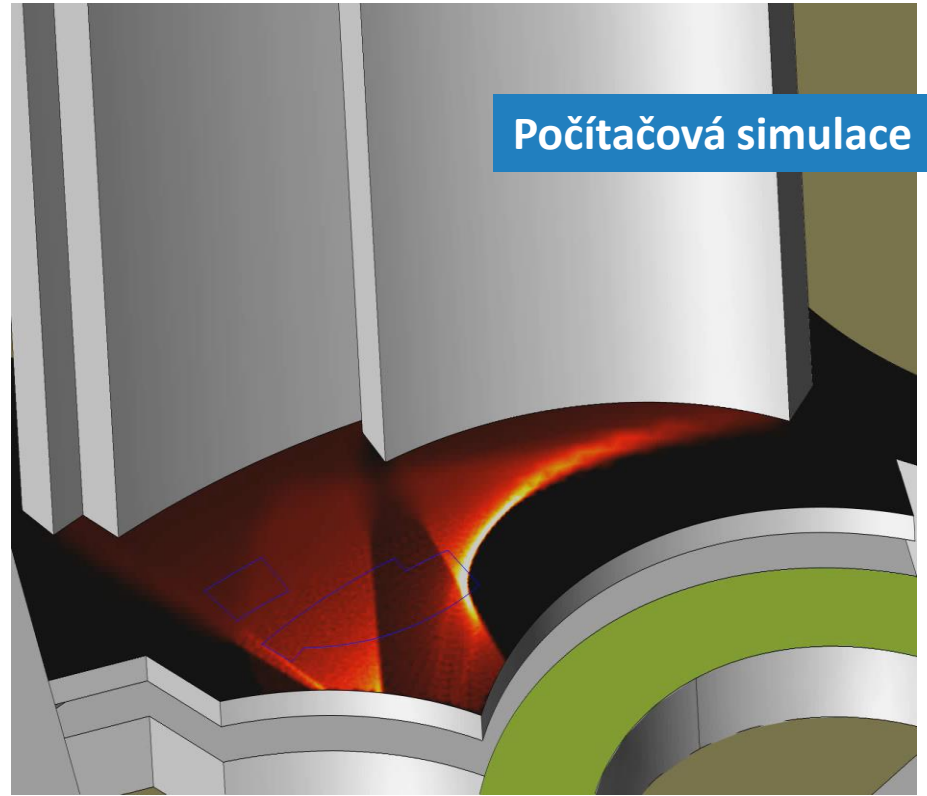

Sdílení aplikace



COMSOL
SERVER™



COMSOL MULTIPHYSICS®

Elektromagnetismus

- AC/DC Module
- RF Module
- Plasma Module
- Semiconductor Module
- MEMS Module

COMSOL MULTIPHYSICS®

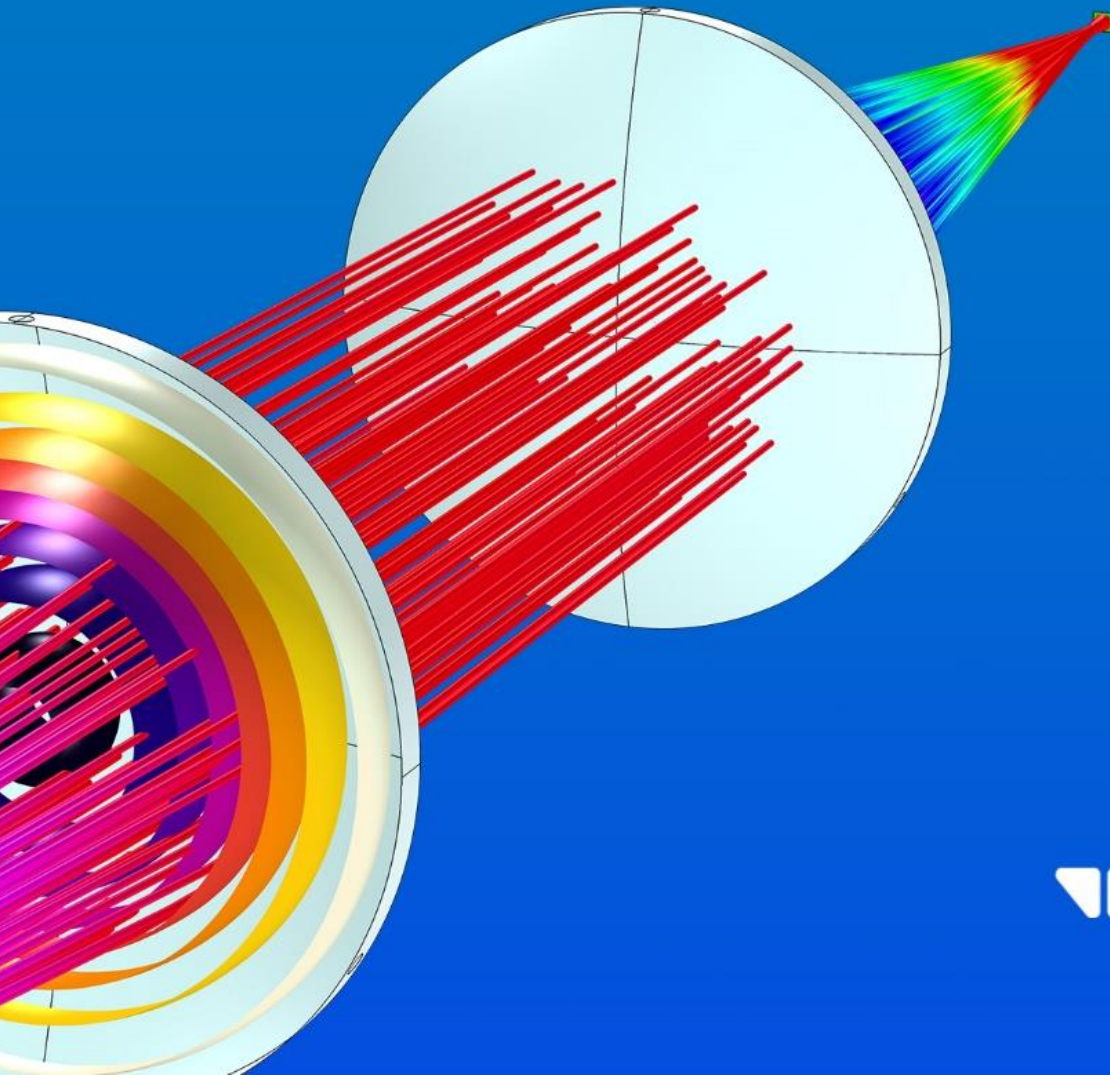

Optika

- Wave Optics Module
- Ray Optics Module

COMSOL MULTIPHYSICS®

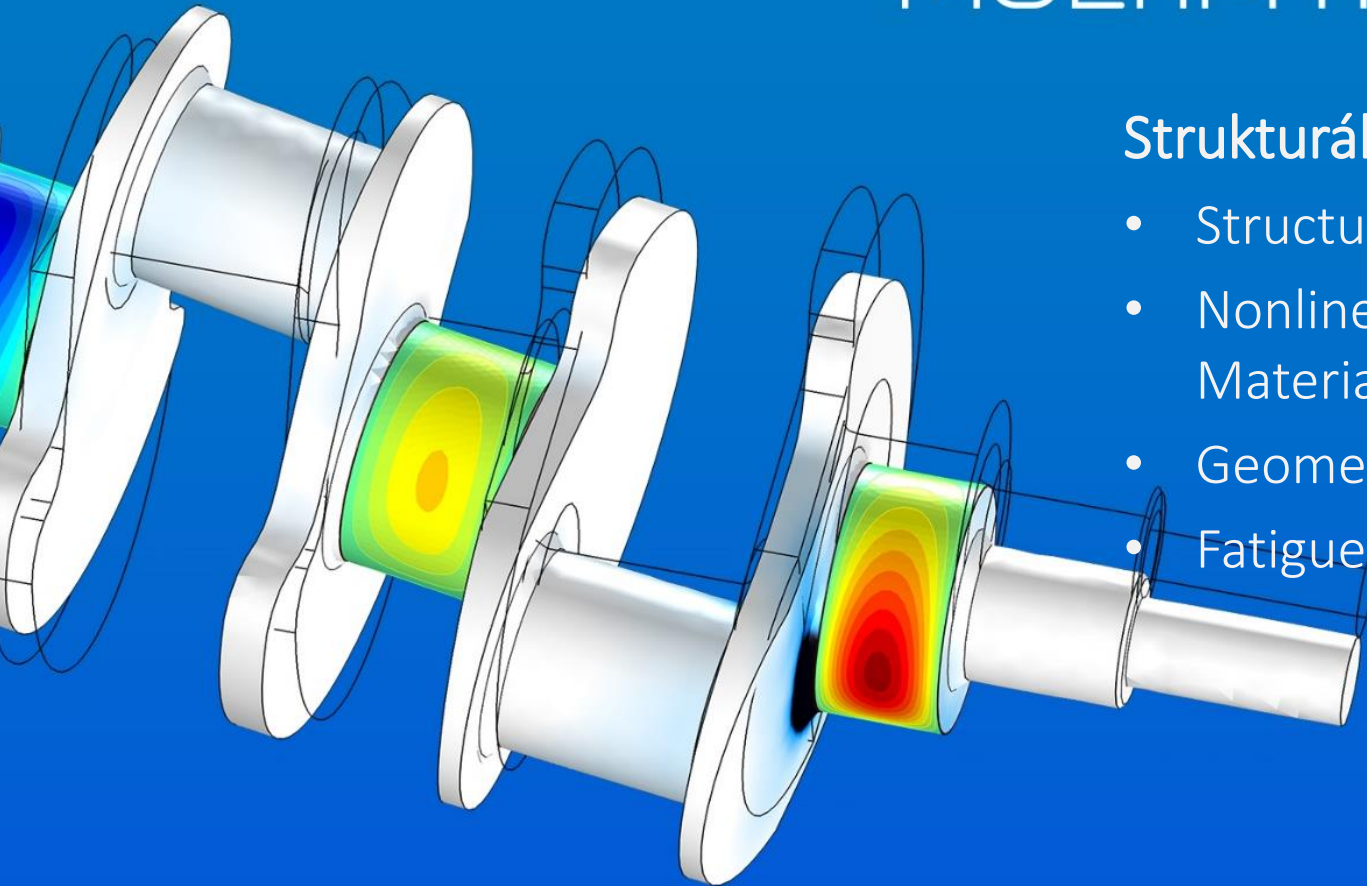

Strukturální mechanika

- Structural Mechanics
- Nonlinear Structural Materials Module
- Geomechanics Module
- Fatigue Module

COMSOL MULTIPHYSICS®

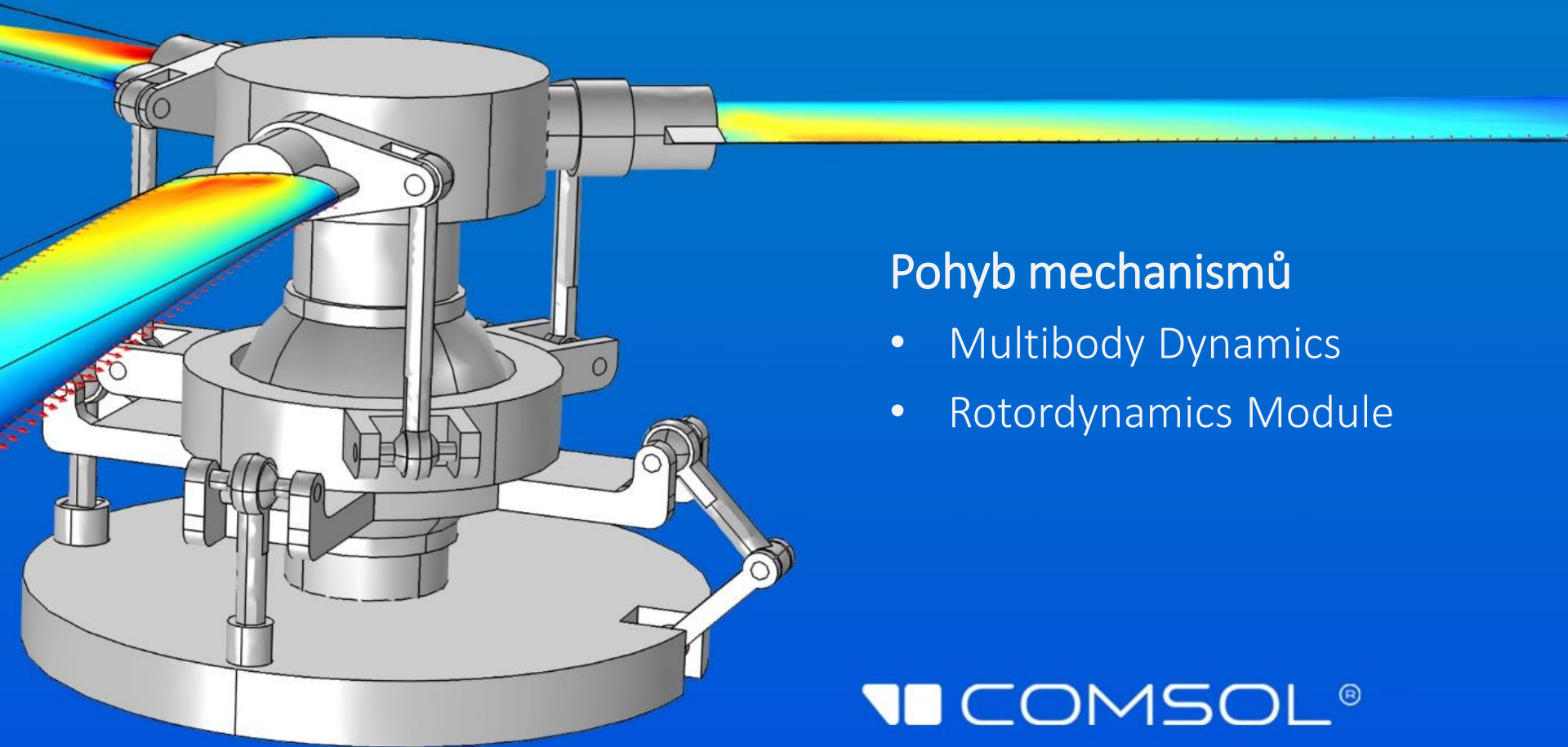

Pohyb mechanismů

- Multibody Dynamics
- Rotordynamics Module

COMSOL MULTIPHYSICS®

Akustika

- Acoustics Module

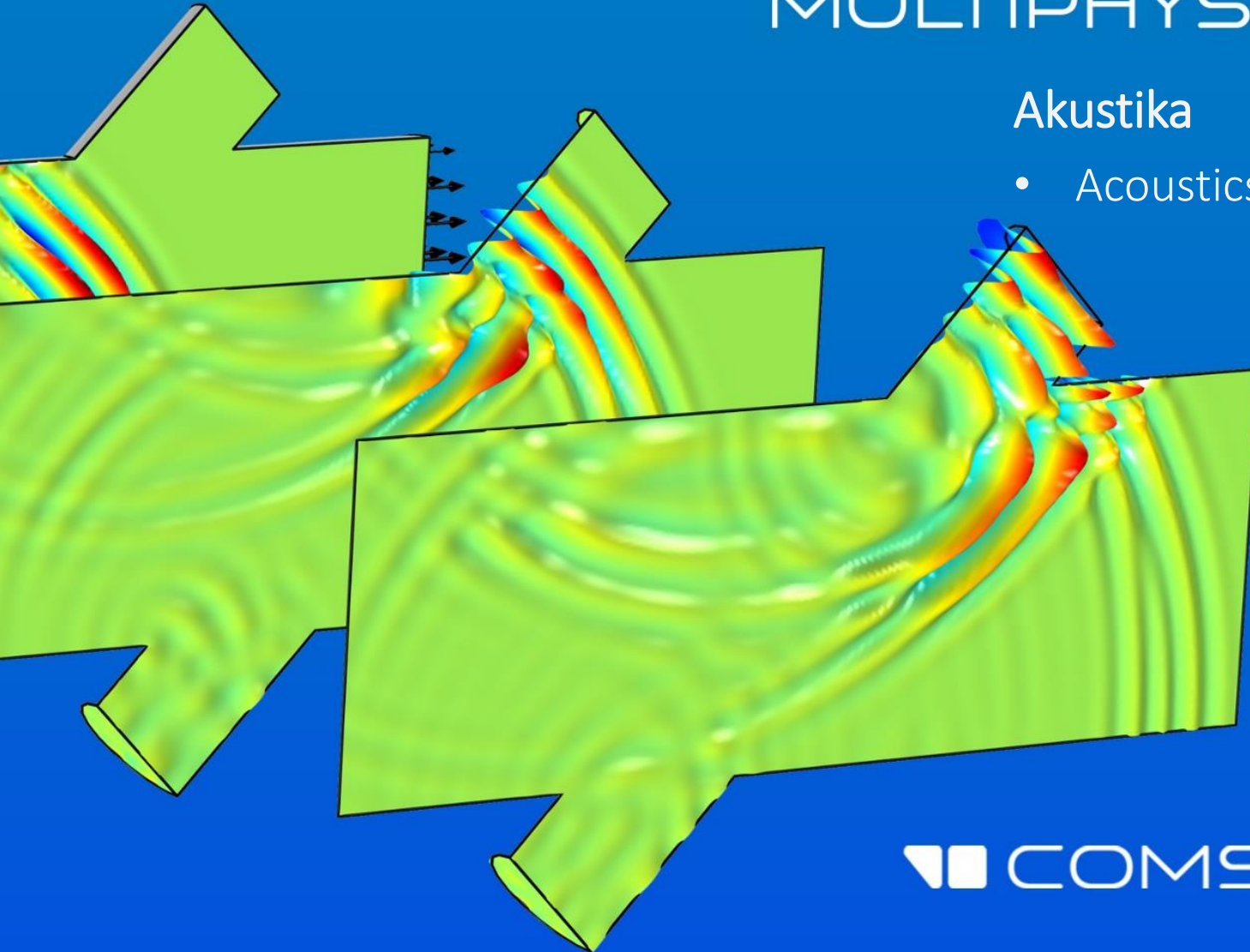

The background features a blue gradient with a complex 3D visualization of fluid flow. Streamlines in shades of blue and yellow flow through and around several grey, curved, metallic-looking objects, illustrating the capabilities of the software in fluid dynamics simulation.

COMSOL MULTIPHYSICS®

Proudění

- CFD Module
- Mixer Module
- Subsurface Flow Module
- Pipe Flow Module
- Microfluidics Module
- Molecular Flow Module



COMSOL MULTIPHYSICS®

Přestup tepla

- Heat Transfer Module

COMSOL MULTIPHYSICS®

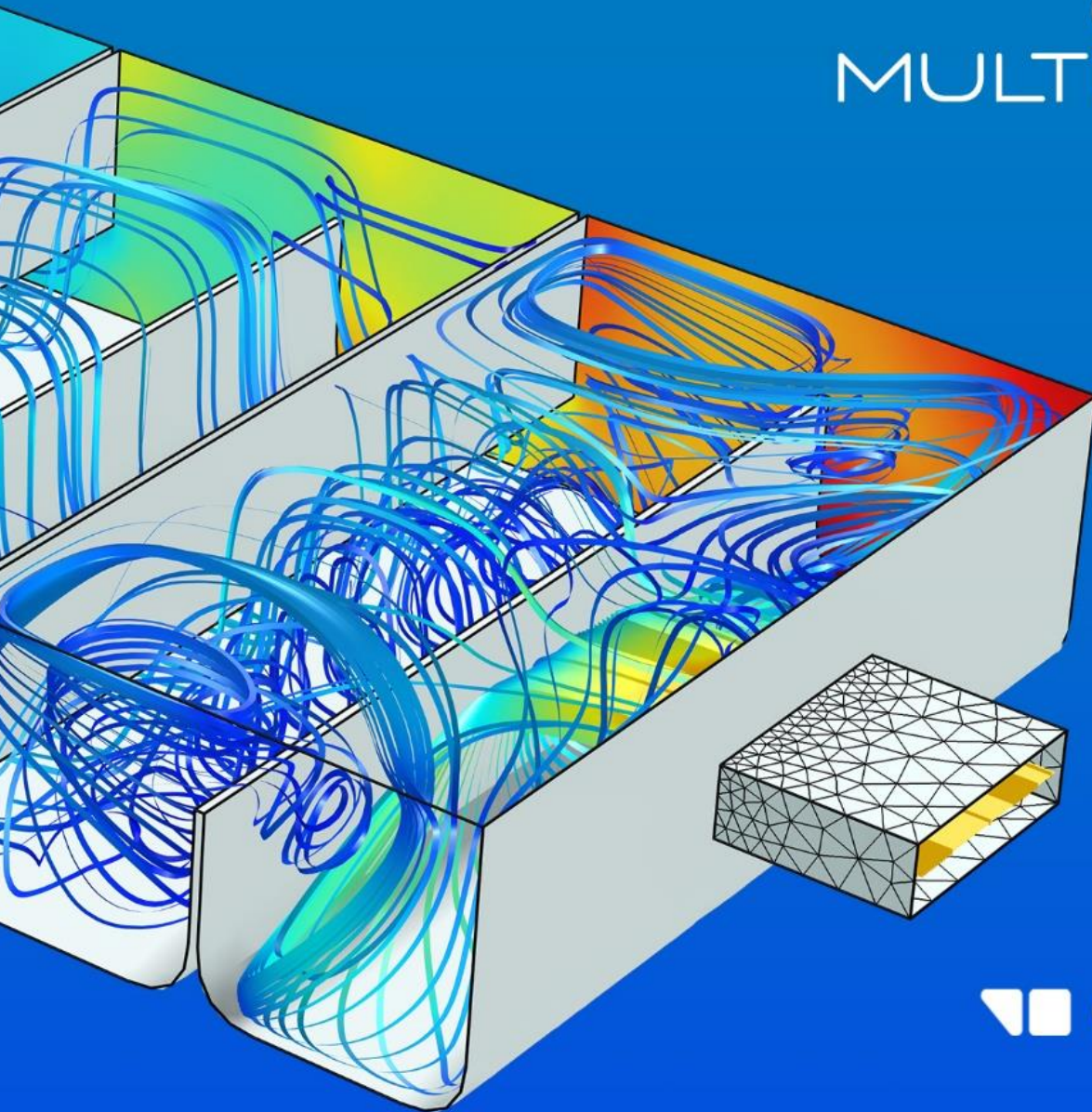

Chemie

- Chemical Reaction Engineering Module
- Batteries and Fuel Cells
- Electrodeposition Module
- Corrosion Module
- Electrochemistry Module

Příklad multifyzikální úlohy:
Indukční ohřev

COMSOL
MULTIPHYSICS®

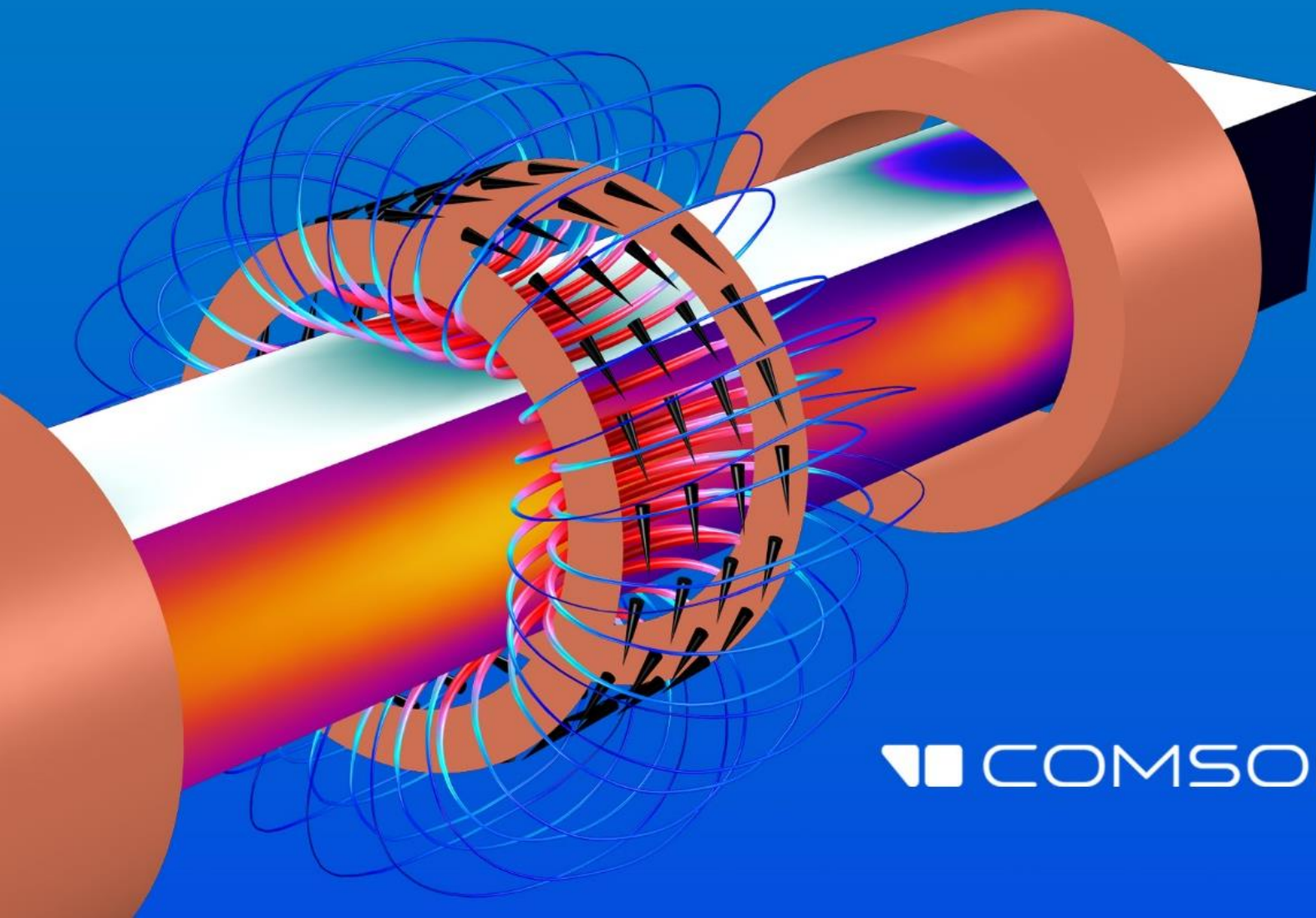

COMSOL®

COMSOL MULTIPHYSICS®

Příklad multifyzikální úlohy:
Šíření hluku od mechanismu převodovky

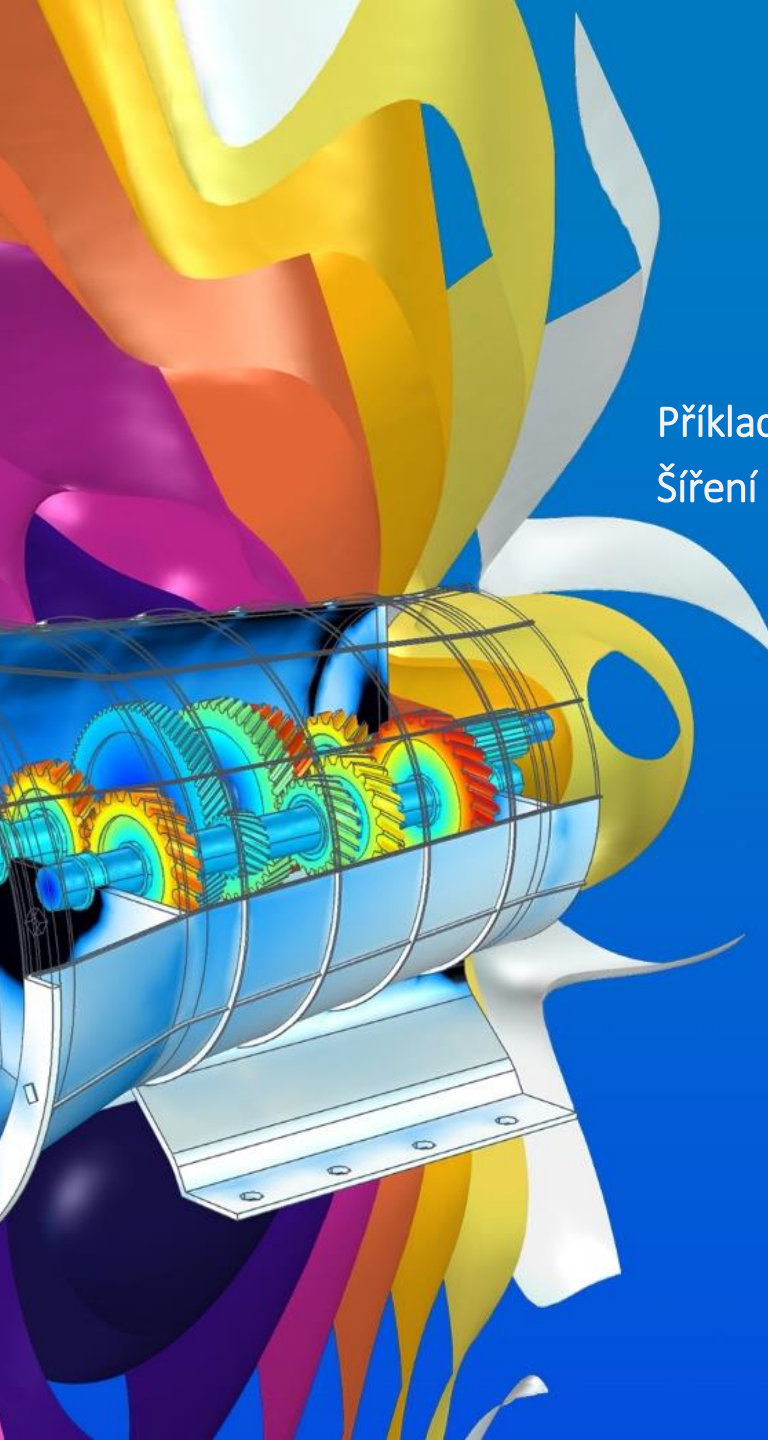

Unikátní řešení pro vědu i průmysl

26 Modulů – jednotné ovládání

Vlastní ODR / PDR

Parametrizujte cokoliv

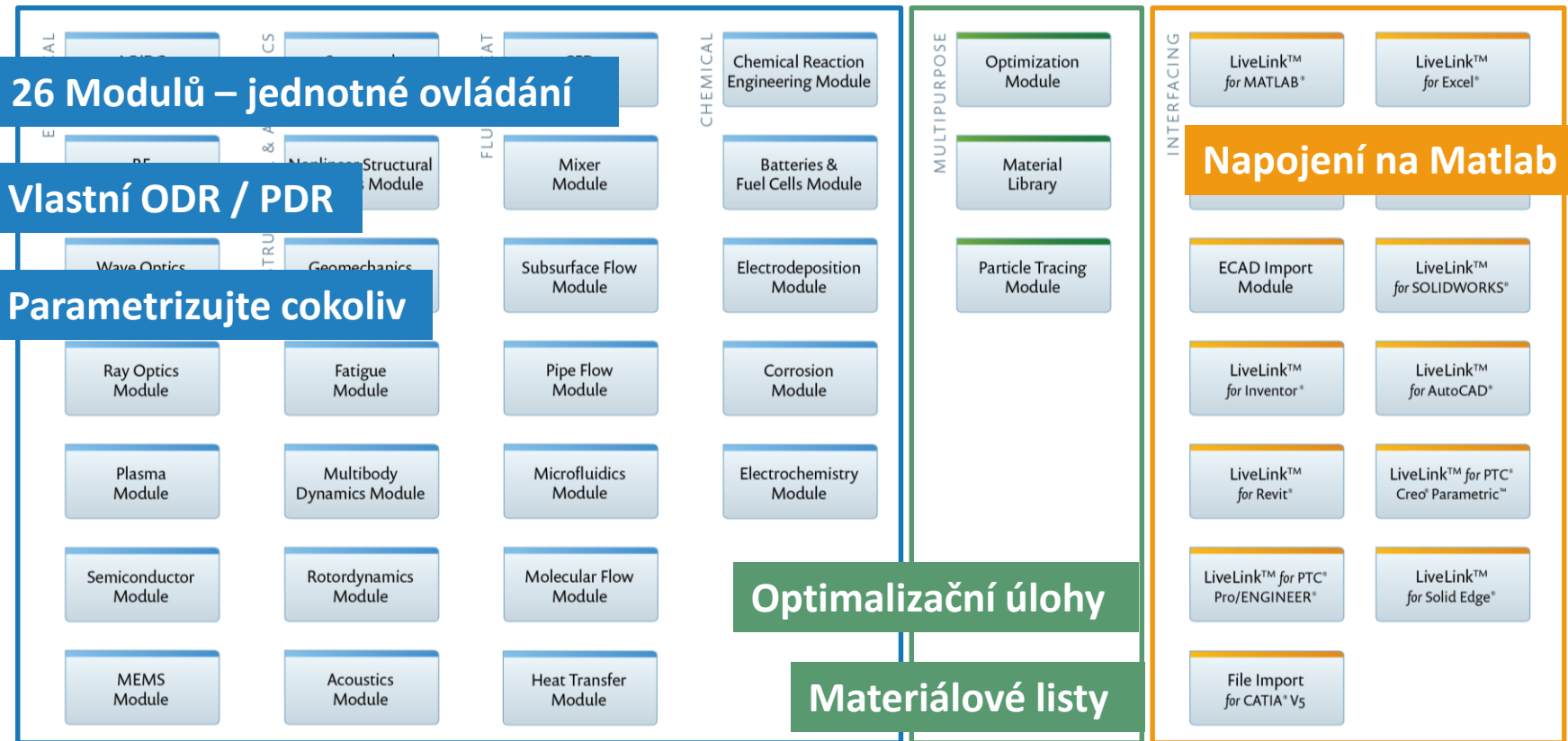

Optimalizační úlohy

Materiálové listy

CKL licence pro univerzity

- Síťová multilicence pro pravidelnou výuku
- Výrazné cenové zvýhodnění
- Zaškolení vyučujících
- Podklady pro zavedení výuky COMSOL 1

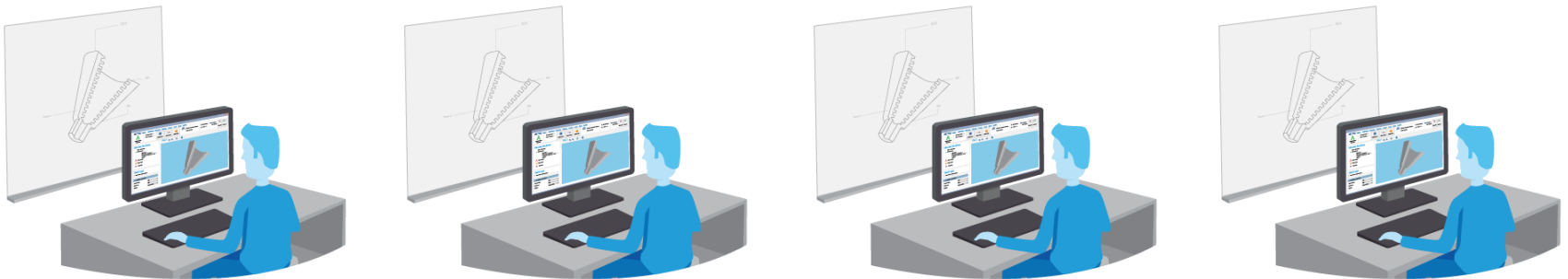



SAVE THE DATE

14. 11. 2017 od 9:00
Workshop Úvod do COMSOL

14. 11. 2017 od 16:00
Workshop Elektromagnetismus
v COMSOL Multiphysics

7. 12. 2017 od 16:00
Workshop tvorba aplikací

www.humusoft.cz/events